

Specifications:
 Housing: LCP UL94-V0 Color: Nature
 Cove: LCP UL94-V0 Color: Black
 Contact: Phosphor Bronze
 Operating Voltage: 50V AC/DC
 Current Rating: 0.4A AC/DC
 Withstand Voltage: 200V AC/Minute
 Contact Resistance: $\leq 20m\Omega$
 Insulation resistance: $\geq 500m\Omega$
 Operating Temperature: $-25^{\circ}C \sim +85^{\circ}C$

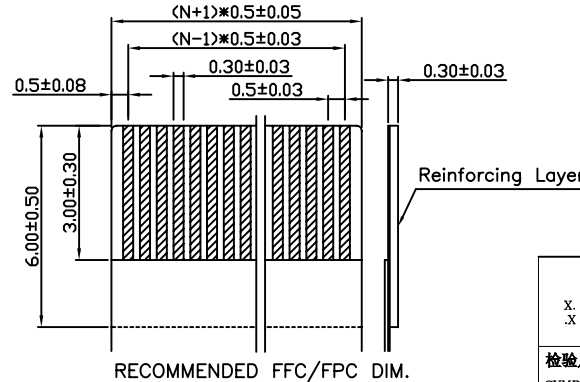
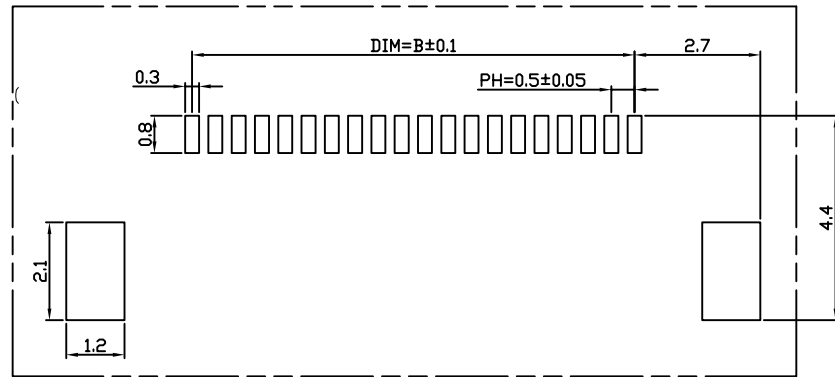
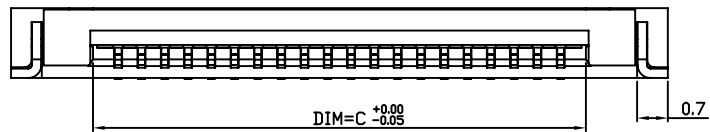
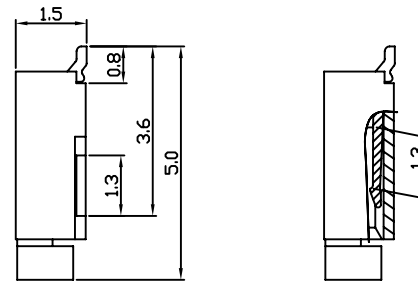
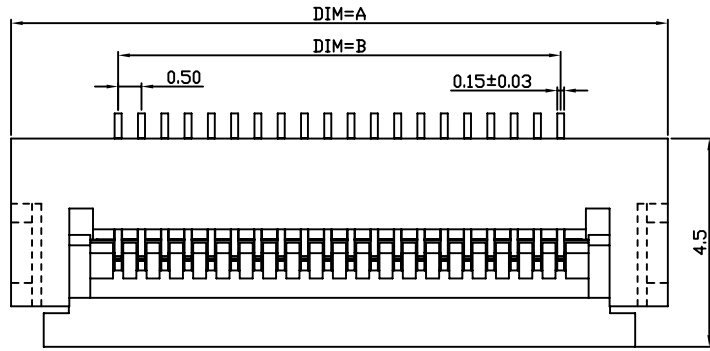
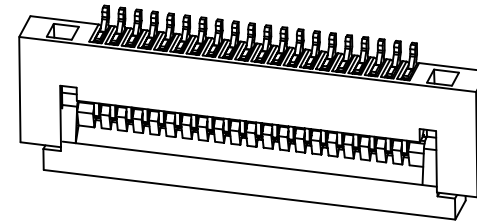
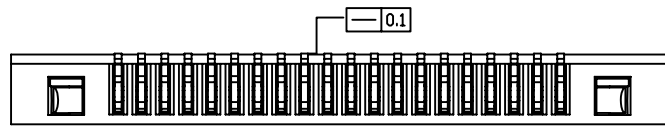

CKT	DIM=A	DIM=B	DIM=C	CKT	DIM=A	DIM=B	DIM=C
4P	6.1	1.5	2.6	33P	2.06	16.0	17.1
5P	6.6	2.0	3.1	34P	21.1	16.5	17.6
6P	7.1	2.5	3.6	35P	21.6	17.0	18.1
7P	7.6	3.0	4.1	36P	22.1	17.5	18.6
8P	8.1	3.5	4.6	37P	22.6	18.0	19.1
9P	8.6	4.0	5.1	38P	23.1	18.5	19.6
10P	9.1	4.5	5.6	39P	23.6	19.0	20.1
11P	9.6	5.0	6.1	40P	24.1	19.5	20.6
12P	10.1	5.5	6.6	41P	24.6	20.0	21.1
13P	10.6	6.0	7.1	42P	25.1	20.5	21.6
14P	11.1	6.5	7.6	43P	25.6	21.0	22.1
15P	11.6	7.0	8.1	44P	26.1	21.5	22.6
16P	1.21	7.5	8.6	45P	26.6	22.0	23.1
17P	12.6	8.0	9.1	46P	27.1	22.5	23.6
18P	13.1	8.5	9.6	47P	27.6	23.0	24.1
19P	13.6	9.0	10.1	48P	28.1	23.5	24.6
20P	14.1	9.5	10.6	49P	28.6	24.0	25.1
21P	14.6	10.0	11.1	50P	29.1	24.5	25.6
22P	15.1	10.5	11.6	51P	29.6	25.0	26.1
23P	15.6	11.0	12.1	52P	30.1	25.5	26.6
24P	16.1	11.5	12.6	53P	30.6	26.0	27.1
25P	16.6	12.0	13.1	54P	31.1	26.5	27.6
26P	17.1	12.5	13.6	55P	31.6	27.0	28.1
27P	17.6	13.0	14.1	56P	32.1	27.5	28.6
28P	18.1	13.5	14.6	57P	32.6	28.0	29.1
29P	18.6	14.0	15.1	58P	33.1	28.5	29.6
30P	19.1	14.5	15.6	59P	33.6	29.0	30.1
31P	19.6	15.0	16.1	60P	34.1	29.5	30.6
32P	20.1	15.5	16.6				

一般公差
TOLERANCES
 X ±0.40 .XX ±0.20
 .X ±0.30 .XXX ±0.10
 ANGLES ±2°

深圳市宏利电子有限公司
Shenzhen Holy Electronic Co.,Ltd

检验尺寸标示 SYMBOLS \odot \ominus INDICATE CLASSIFICATION DIMENSION \odot MARK IS CRITICAL DIM. \ominus MARK IS MAJOR DIM.	工程图号 FPC0515FG-nP	制图 (DR) *10/03/22 审核 (CHKD)
表面处理 (FINISH)	品名 FPC0.5mm -nP H1.5 翻盖下接	核准 (APPD) Rigo Lu
比例 (SCALE) 1:1	TITLE FPC0.5mm Pitch H1.5mm Flip ZIF CONN	张数 (SHEET) 1 OF 1
单位 (UNITS) mm	尺寸 (DIMENSION)	尺寸 (SIZE) A4
日期 (DATE)	签名 (SIGNATURE)	版本 (REV) 0

修订 REV	修改摘要 REVISION DESCRIPTION	日期 DATE	签名 SIGNATURE